

Infrared Presence Sensor

Model: ST47-B/ST47-N
MANUAL OVERRIDE

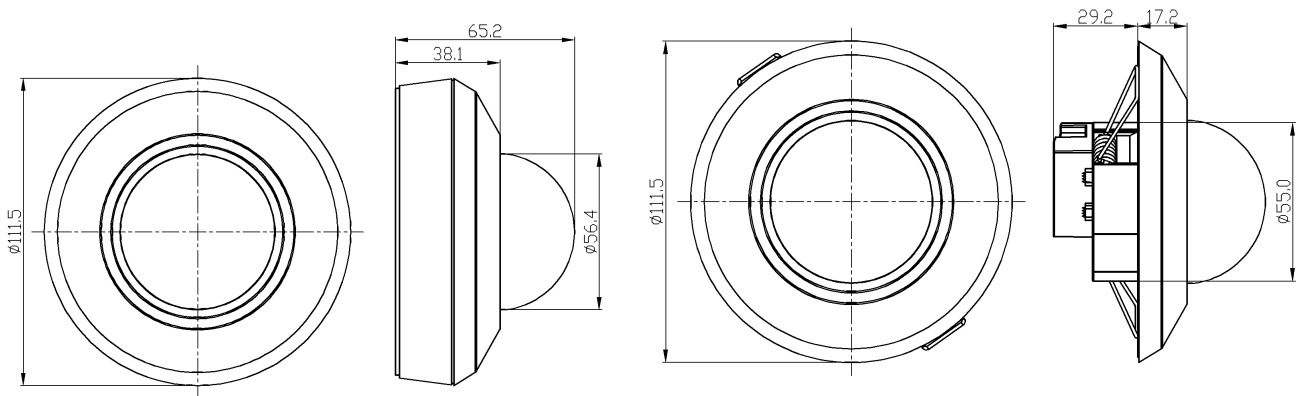

Instruction

Welcome to use ST47-B /ST47-N infrared presence sensor!

Congratulation on purchasing your new sensor and thank you for the confidence you have shown in us. You have chosen a high-quality product that has been manufactured, tested and packed with the greatest care. Please familiarize yourself with these instructions before attempting to install the product because prolonged, reliable and trouble-free operation will only be ensured if it is fitted and used properly. We hope your new sensor will bring you lasting pleasure.

SPECIFICATION:

Power Source: 220-240V/AC

Power Frequency: 50/60Hz

Ambient Light: <3-2000LUX (adjustable)

Time Delay: Min.10sec±3sec

Max.30min±2min

Rated Load: Max.2000W

1000W



Detection Range: 360°

Detection Distance: 20m max(<24°C)

Working Temperature: -20~+40°C

Working Humidity: <93%RH

Power Consumption: approx 0.5W

Installation Height: 2.2-6m

FUNCTION:

- Can identify day and night: The consumer can adjust working state in different ambient light. It can work in the daytime and at night when it is adjusted on the “sun” position (max). It can work in the ambient light less than 3LUX, when it is adjusted on the “3” position (min). As for the adjustment pattern, please refer to the testing pattern.
- Time-Delay is added continually: When it receives the second induction signals within the first induction, it will restart to time from the moment.

MANUAL OVERRIDE FUNCTION:

1. Sensor mode → Stay on

Now switch wall switch OFF-ON, OFF-ON twice within 3seconds. The sensor will now hold your light ON continuously just likes a normal light.

2. Stay on → Sensor mode(The following either method is ok)

1).Switch your wall switch OFF, then switch ON after 0.3seconds.

2). If the light left ON (not change the sensor to sensor mode by hand), the sensor itself will also automatically return to the sensor mode after 8hours.

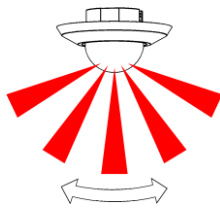

Good Sensitivity

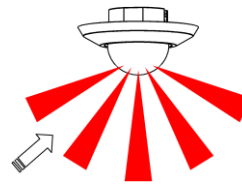
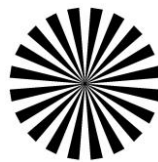

Poor Sensitivity

INSTALLATION ADVICE:

As the detector responds to changes in temperature, avoid the following situations:

- Avoid pointing the detector towards objects with highly reflective surfaces, such as mirrors etc.
- Avoid mounting the detector near heat sources, such as heating vents, air conditioning units, light etc.
- Avoid pointing the detector towards objects that may move in the wind, such as curtains, tall plants etc.

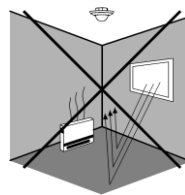
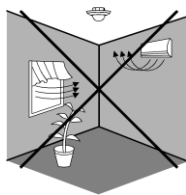
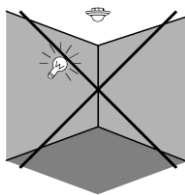

CONNECTION:

	WARNING
	Warning. Danger of death through electric shock!
	<ul style="list-style-type: none">● Must be installed by professional electrician.● Disconnect power source.● Cover or shield any adjacent live components.● Ensure device cannot be switched on.● Check power supply is disconnected.

INSTALLATION (3 methods):

Method 1: Recessed mounting

- Unload the vinyl cover which is at the bottom of the sensor.
- Loosen the screws in the connection terminal, and then connect the power to connection terminal of sensor according to connection-wire diagram.
- Install back the vinyl cover into the original location.
- Fold the metal spring of the sensor upwards, until they are in "I" position with sensor, and then put the sensor into the hole or installation box which is on the ceiling and has the similar size with the sensor. Releasing the spring, the sensor will be set in this installation position.
- After finishing installing, turn on the power and then test it.

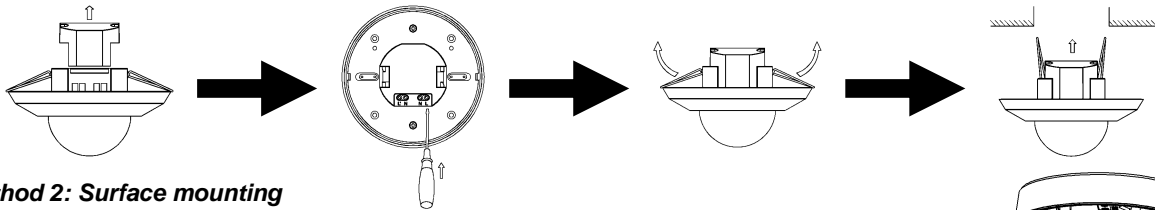

Method 2: Surface mounting

- Please remove the metal spring of the sensor, and use the bottom casing.
- Please move the upper cover with anti-clockwise whirl as per the diagram on the right.
- Connect the power and the load according to the connection-wire diagram.
- Fix the bottom casing on the selected position with the inflated screw.
- Install back the upper cover on the sensor, then you could switch on the power and test it.

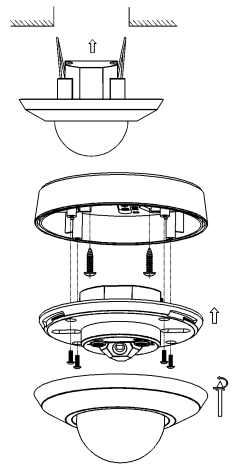

Method 3: Mounting in junction box

- Please remove the metal spring and bottom casing of the sensor.
- Loosen the screws in the connection terminal, and then connect the power to connection terminal of sensor according to connection-wire diagram.
- Install the sensor into the junction box, fix the screw through the mounting hole (refer to figure).
- Install back the faceplate, switch on the power and then test it.

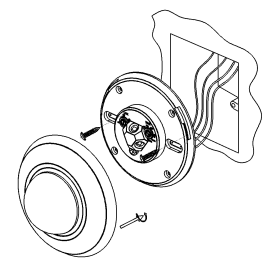

CONNECTION-WIRE DIAGRAM:

(See the right figure)

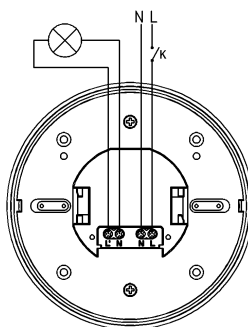

SENSOR INFORMATION:

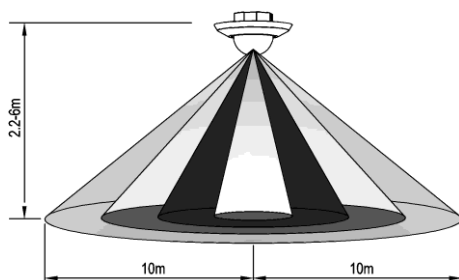

Height of installation: 2.2-6m

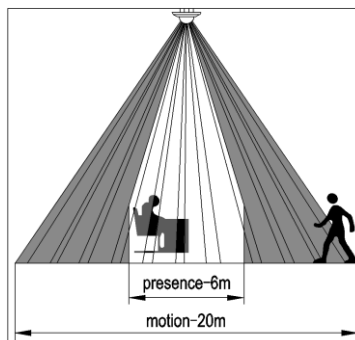

Detection Distance: Max.20m

TEST:

- Turn the TIME knob anti-clockwise on the minimum (10s). Turn the LUX knob clockwise on the maximum (sun).
- Switch on the power; the sensor and its connected lamp will have no signal at the beginning. After Warm-up 30sec, the sensor can start work .If the sensor receives the induction signal, the lamp will turn on. While there is no another induction signal any more, the load should stop working within $10\text{sec} \pm 3\text{sec}$ and the lamp would turn off.
- Turn LUX knob anti-clockwise on the minimum (3). If the ambient light is more than 3LUX, the sensor would not work and the lamp stop working too. If the ambient light is less than 3LUX (darkness), the sensor would work. Under no induction signal condition, the sensor should stop working within $10\text{sec} \pm 3\text{sec}$.

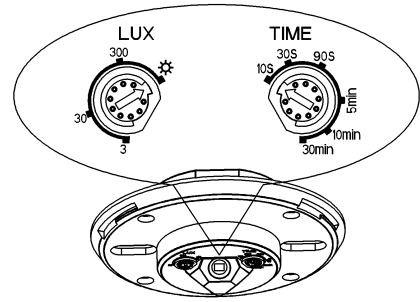

Note: when testing in daylight, please turn LUX knob to ☀ (SUN) position, otherwise the sensor lamp could not work! If the lamp is more than 60W, the distance between lamp and sensor should be 60cm at least.

SOME PROBLEM AND SOLVED WAY:

- The load do not work:
 - a. Please check if the connection-wiring of power and load is correct.
 - b. Please check if the load is good.
 - c. Please check if the working light sets correspond to ambient light.
- The sensitivity is poor:
 - a. Please check if there has any hindrance in front of the detection window to affect to receive the signal.
 - b. Please check if the ambient temperature is too high.
 - c. Please check if the induction signal source is in the detection fields.
 - d. Please check if the installation height corresponds to the height showed in the instruction.
 - e. Please check if the moving orientation is correct.
- The sensor can not shut off the load automatically:
 - a. Please check if there is continual signal in the detection field.
 - b. Please check if the time delay is the longest.
 - c. Please check if the power corresponds to the instruction.